

PHYSION™

User Guide

Eventide®

Copyright 2017, Eventide Inc.

P/N 141291, Rev 6

Eventide is a registered trademark of Eventide Inc.

AAX and Pro Tools are trademarks of Avid Technology. Names and logos are used with permission.

Audio Units is a trademark of Apple, Inc.

VST is a trademark of Steinberg Media Technologies GmbH.

All other trademarks contained herein are the property of their respective owners.

Eventide Inc.

One Alsan Way

Little Ferry, NJ 07643

201-641-1200

www.eventideaudio.com

Contents

1	Physion Introduction	1
2	About This Manual	1
3	Registration, Activation, and Installation	1
3.1	Registering Your Plug-in	1
3.2	Activating Your License	2
3.3	Installing Your Plug-In	2
3.4	Moving or Removing an Activation	2
4	Physion Overview	3
5	Structural Split Processing	4
5.1	Source Type	4
5.2	Focus	4
5.3	Smoothing	5
5.4	Trans Decay	5
5.5	Structural Split On/Off	5
5.6	Waveform Viewer	5
6	Transient Processing	6
6.1	Transient Effects	6
6.1.1	Transient Delay	6
6.1.2	Transient Tap Delay	6
6.1.3	Transient Dynamics	7
6.1.4	Transient Phaser	7
6.1.5	Transient Reverb	8
6.1.6	Transient Gate+EQ	8
6.2	Transient Effects On/Off	9
6.3	Transient Gain	9
6.4	Transient Solo	9
6.5	Transient Output Meter	9
7	Tonal Processing	10
7.1	Tonal Effects	10
7.1.1	Tonal Delay	10
7.1.2	Tonal Compressor	10
7.1.3	Tonal Pitch	11
7.1.4	Tonal Chorus	11
7.1.5	Tonal Reverb	12
7.1.6	Tonal Tremelo	12
7.1.7	Tonal EQ	13
7.2	Tonal Effects On/Off	13
7.3	Tonal Gain	13
7.4	Tonal Solo	13
7.5	Tonal Output Meter	13
8	Preset Bar	14
8.1	Global Mix	14
8.2	Global Gain	14
8.3	Saving and Recalling Plug-In Settings	14
8.4	Compare	14
8.5	Info	14
8.6	Source Lock	14
9	Conclusion	15

1 Physion Introduction

An entirely new type of effect, Physion separates the incoming audio signal into two parts based on the signal's structure, in this case Transient content and Tonal content. These two independent streams are processed individually with custom Eventide effects, and then combined in (close to) real time. Because the Transient and Tonal structures of the signal are processed separately, Physion lends itself to some very useful and interesting mixing and sound design purposes that haven't before been possible.

Physion features:

- New Structural Split technology, which allows for complete separation of Transient or Tonal audio content.
- 6 custom Eventide effects on the Transient stream.
- 7 custom Eventide effects on the Tonal stream.
- Handy post-Structural Split Waveform Viewer
- Preset bar for easily saving and recalling presets

2 About This Manual

While we're confident you'll be able to use your new plug-in without reading this manual, we urge you to have a quick look. There are several unique features and interesting options presented in Physion and a cursory glance will illuminate any features you may overlook. We'll try to keep it all relevant and highlight any tips or cool tricks for you. We also won't cover much at all about the operation of your plug-in host or the macOS or Windows environments, as their owner's manuals or online help should provide you with the answers you need. We've made every attempt to integrate the standard controls and features from the major plug-in hosts into our plug-ins so that you don't have to learn anything new. If you find the need to get more information from us than this manual can provide, please visit our support forum available via our website (<http://www.eventideaudio.com>).

Note that you can access this manual directly from the plug-in by clicking the "INFO" button in the preset bar.

3 Registration, Activation, and Installation

Eventide uses PACE's ilok.com licensing system, with or without an iLok hardware dongle, to license our plug-in products. Each license provides two activations which can reside on either your computer or on an iLok license dongle. Once you've purchased your plug-in, you'll need to register it on Eventide's website, activate your license, and install the plug-in on to your computer.

3.1 Registering Your Plug-in

When you purchase an Eventide Native plug-in, you'll receive a Serial Number and License Key. The Serial Number will be two letters followed by 6 numbers. The Serial Number will start with FI (i.e. FI-#####). The License Key will be 3 sets of 4 characters, a letter or a number, each; like XXXX-XXXX-XXXX.

Once you've received these codes, you can register your plug-in on the Eventide website. To do so, please log in to <http://www.eventideaudio.com>, navigate to My Account in the top right corner, and select Register a New Product. Then, fill out the form by selecting Native Plug-in (VST, AU, AAX) in the Product Category field, select Physion in the Product list, and enter your Serial Number, License Key, and ilok.com account name. If you don't yet have an ilok.com account, you can create one for free at <http://www.ilok.com>. Once you've done so, press Register.

Once you've entered this information and pressed the Register button, Eventide will send the applicable plug-in license to your ilok.com account, which you will need to activate to your computer or iLok dongle.

3.2 Activating Your License

To activate and manage your plug-in licenses you'll need to install PACE's iLok License Manager software which you can download from <http://www.ilok.com>. If you don't have this software installed, please download and install it now.

Once you have installed and launched iLok License Manager you should be able to log in to your account by clicking the large Sign In button in the upper left hand corner of the application. Once you have, you should be able to see available licenses by choosing the Available tab at the top of the iLok License Manager application. If you have successfully registered your plugin, your Physion license will be available in this list. Please activate this license by dragging it to either your computer or iLok dongle listed on the left. When you do so, you will be asked to confirm the activation, and you will be able to see it by clicking on the location you have chosen. At this point your license is activated.

3.3 Installing Your Plug-In

You should have been given a link to the Eventide Native plug-in installer when you purchased your plug-in, but if you haven't, you can find downloads for all of Eventide's Native Plug-Ins at <http://www.eventideaudio.com/products/plugins>. Please download and launch the correct installer for your system.

Once you've launched the plug-in installer, it will take you through several pages of options. We have tried to choose defaults for these options which will best serve the majority of users, but it is worth a minute to make sure you understand these options before clicking through to the next page. Once you have followed through the installer, your plug-ins and presets should be in your chosen locations, and you can hit finish to end the installer application.

Note that if you are using the VST format in a Windows DAW, it is possible that you need to add the file paths where you chose to install Physion to the DAW's VST preferences.

At this point, you should be ready to use your Physion Plug-In.

3.4 Moving or Removing an Activation

If at any point, you decide to move your plug-in activation, you can do so in iLok license manager. To move an activation between an iLok dongle and your computer, simply plug in the iLok, locate the license in its current location, and drag it to its new location. To deactivate a license, find it in its location, right click on it, and choose deactivate.

Remember that each Eventide Native Plug-In License comes with two activations, which can be used on either a computer or iLok dongle, meaning you can use Physion in two locations at the same time.

4 Physion Overview



Figure 1: Physion Plug-in

The Physion user interface is divided into four main horizontal sections, each serving a unique purpose. However, it should be noted that the most important section to set first is the **Structural Split** section, as this controls the flexibility and efficiency of the splitting algorithm. The four sections are:

- The **Preset Bar**, which lets you choose from Factory and User Presets
- The **Transient Effects** section, which applies effects to the Transient content of your signal
- The **Structural Split** section, which performs the separation magic
- The **Tonal Effects** section, which applies effects to the Tonal content of your signal

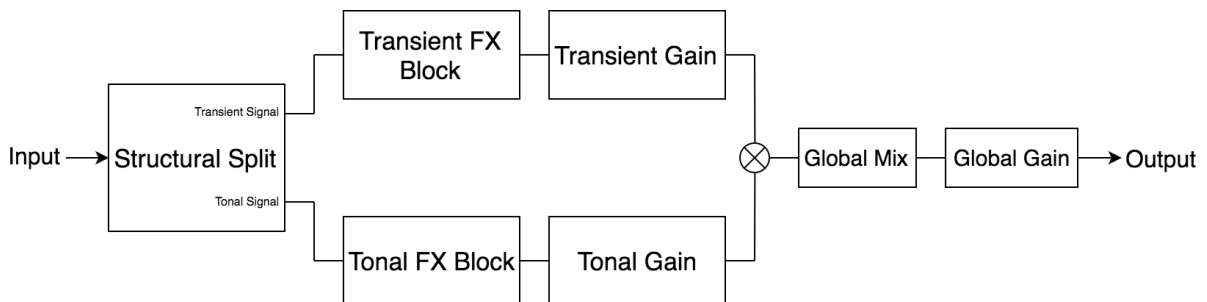

Figure 2: Physion Signal Flow

Additionally, keep in mind that the following features apply to all Physion controls:

- Values can be changed by dragging up or down, or by typing into the corresponding text box
- Double clicking or Opt + clicking on any control will revert it to its default value
- Cmd + dragging on any control will result in more precise range of motion
- All controls are automatable

5 Structural Split Processing

The Structural Split Controls allow for user specific tuning of the Transient / Tonal separation via four control parameters: Source Type, Focus, Trans Decay, and Smoothing.

The Structural Split is a completely complementary division of the audio. The individual Transient and Tonal audio streams automatically mix back together in Physion to perfectly reconstruct the input signal (until you start doing all the fun stuff by effecting them differently!), so remember, you will not hear any change in audio as you move these parameters unless you solo an individual Transient or Tonal channel, change the Transient / Tonal gains, or apply a unique Transient or Tonal effect. It is recommended that for optimizing the Split, you bypass both Transient / Tonal FX and solo each audio stream as you set the Split parameters.

Even if you do not apply any of the above suggestions to hear the separation, you'll still be able to see Transient / Tonal split in the the Waveform Viewer to the right of the Structural Split Controls. This viewer displays the resulting input Transient / Tonal Split, with each colored-coded waveform, blue Transient and green Tonal, visually overlaid atop the gray original signal waveform.

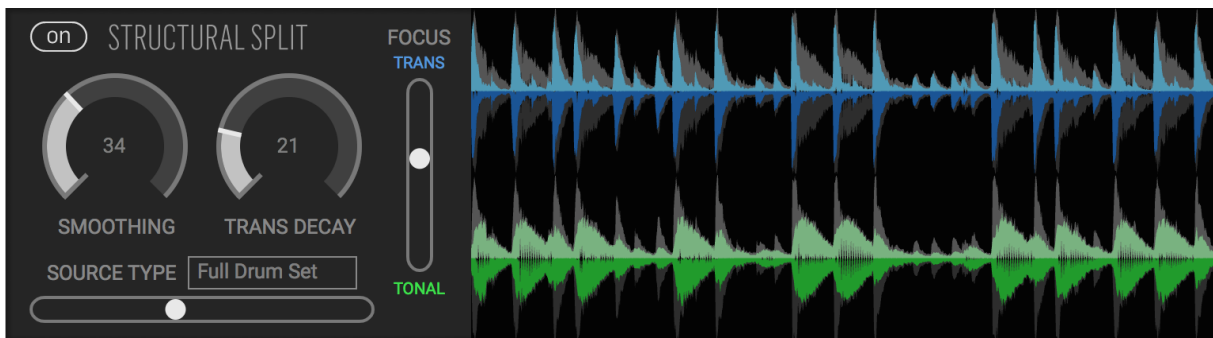

Figure 3: Structural Split Section

5.1 Source Type

This combo horizontal slider / menu box includes "coarse" algorithmic tunings for different audio sources as suggestions for the separation task, so it's generally best to match the Source Type to the audio you're wanting to process through Physion. But, by all means, don't let these suggestions deter you from being adventurous in trying different tunings on different source material.

These coarse Source Type tunings essentially scale the internal algorithm parameters used by the Focus Control to split the input audio. Tunings for higher polyphony or complexity (full drums, electronic beat, piano, guitar, vocal) tend to split best on source material that has higher polyphony or complexity.

5.2 Focus

True to its name, this vertical slider control "focuses" the sonic energy towards either the Transient or Tonal audio channel, with extreme settings pushing all the energy into either Transient (top of slider) or Tonal (bottom of slider). However, the real separation magic occurs in the middle settings, where Focus sets the main transition region or decision point where audio splits (in time and frequency) into the separate Transient and Tonal streams.

Pushing more energy into the Transient channel will create musical auto-swelling in the Tonal channel. Alternatively, pushing more energy into the Tonal Channel will trim the Transient audio into staccato transients devoid of tonal resonance. You can also use Focus to morph audio signals between two parallel effects. But instead of a simple cross fade, the audio transitions through the "Split Domain".

5.3 Smoothing

The Smoothing control is a fine tuning control used to slow down the fastest transitions (in time and frequency) in both directions between Transient and Tonal. Basically, this controls how fast a piece of Transient or Tonal audio can switch to the other stream. This is primarily used to smooth out any artifacts that you may encounter with difficult source signals. It can however be musically useful in creating softer Transient attacks.

5.4 Trans Decay

An extension of Smoothing (but only in one direction), the Transient Decay control limits how quickly audio is allowed to transition (in time and frequency) from Transient to Tonal, thus increasing the decay on the Transients. Larger values of Trans Decay limit the transition rate substantially. This control could equally be named Tonal Swell, as larger values will also increase the auto-swell period in the Tonal Channel.

Not only is this useful for smoothing out artifacts, but as a musical tool at larger values allows for precision control of auto-swell on the Tonal side of the audio, or conversely the "muted" or "choked" staccato sound of the Transients. As an example, by soloing the Tonal channel and using Focus and Trans Decay you can turn struck or plucked string instruments into beautiful bowed sounding pads.

5.5 Structural Split On/Off

The Structural Split On/Off Button turns the Structural Split process on and off. When off, it renders the Transient / Tonal Split into a simple volume crossfader between two parallel effect channels. Essentially, for your convenience, we allow Physion to become a simple parallel effects processor. When the Structural Split section is off, Focus becomes the pre-effect mixer for the parallel effects processor (all other Split controls do not function). For example, an equal Focus (middle of slider) simply divides the input audio volume by half into each channel before the audio hits the effects.

5.6 Waveform Viewer

Directly to the right of the Structural Split Controls, the Waveform viewer displays the resulting post Structural Split waveforms, with the Transient audio in the top blue viewer and the Tonal audio in the bottom green viewer. All waveforms are displayed pre-Effect and pre-Gain.

Each split signal is visually overlaid atop the original input audio in gray, highlighting the unique three dimensional (time, frequency, and signal magnitude) nature of the split. In other words, we're not just applying time domain dynamics processing here to pull out the attacks of signals.

For stereo Physion instantiations, stereo waveforms will appear with the left channel magnitude in the positive direction and right channel magnitude in the negative direction.

If the message "Waveform Display Unavailable" is displayed, this means that your computer's graphics card does not support the OpenGL graphics library needed for waveform drawing. While you won't be able to view the waveforms, the Structural Split (and the rest of the plug-in) is still functioning properly.

6 Transient Processing

6.1 Transient Effects

Post Structural Split, the Transient signal is independently processed through a selectable Effect Block. The effect is selected with the dropdown menu in the upper right-hand corner of the Effect Block. The Transient Effect choices are:

6.1.1 Transient Delay

A standard Delay echo effect with Tempo Sync capability and low and high cut filtering.

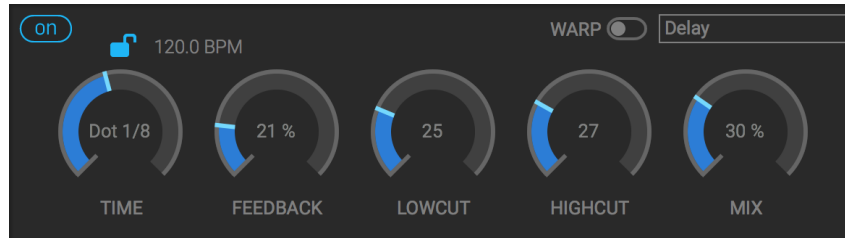

Figure 4: Transient Delay

Controls:

- **Tempo Sync Mode** - toggles between session synced (🔒 symbol), manually synced (🔓 symbol), and free-running (🕒 symbol) delay time.
- **Tempo Sync BPM** - sets the BPM when in manually synced Tempo Sync Mode, and displays the session BPM when in session synced Tempo Sync Mode.
- **Warp** - controls whether changing delay time causes a tape echo type glide (Warp on) or crossfade (Warp off).
- **Time** - amount of delay, up to 4 seconds.
- **Feedback** - amount of delay output that is fed back into delay. Going above 100% allows for self-oscillation.
- **Low Cut** - amount of low frequency rolloff. Low Cut is in the feedback path.
- **High Cut** - amount of high frequency rolloff. High Cut is in the feedback path.
- **Mix** - amount of delayed signal to dry signal.

6.1.2 Transient Tap Delay

A multi-tap delay-line with Tempo Sync capability. Useful for rhythmic delays, wacky comb filtering, volume swells, or unique reverberant sounds.

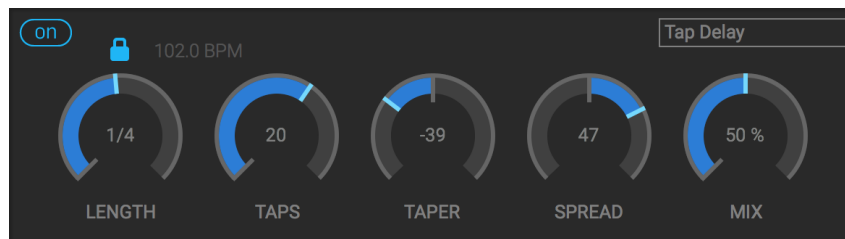

Figure 5: Transient Tap Delay

Controls:

- **Tempo Sync Mode** - toggles between session synced (🔒 symbol), manually synced (🔓 symbol), and free-running (🕒 symbol) delay time.
- **Tempo Sync BPM** - sets the BPM when in manually synced Tempo Sync Mode, and displays the session BPM when in session synced Tempo Sync Mode.

- **Length** - total time over which the taps are spaced, up to 4 seconds.
- **Taps** - the number of delay taps, up to 32 taps.
- **Taper** - controls the fade of the taps over the delay length. More negative values will increasingly give a fade-up over the taps, and more positive values will give a fade-down over the taps.
- **Spread** - rhythmic spacing of the taps over the delay length. More negative values will group taps towards the beginning, while positive values will group taps more towards the end of the delay length.
- **Mix** - amount of delayed signal to dry signal.

6.1.3 Transient Dynamics

A combined Compressor/Limiter and Expander/Gate (function is determined by Ratio control).

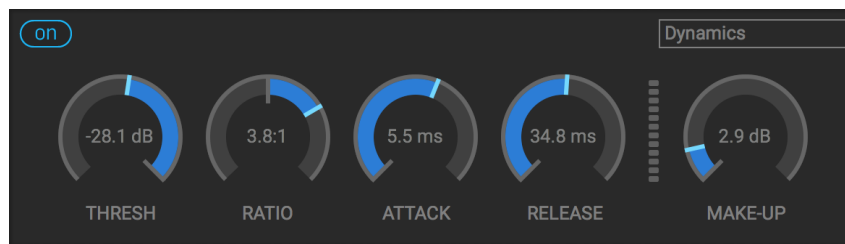

Figure 6: Transient Dynamics

Controls:

- **Threshold** - the gain crossover point. In Compression mode, signals above this level will trigger gain reduction, while in Expansion mode signals below this level will have gain reduction applied.
- **Ratio** - how much gain reduction occurs. If turned left of center, the effect functions as an Expander/Gate. If turned right of center, the effect functions as a Compressor/Limiter.
- **Attack** - how fast the dynamics processor reacts to change in input level.
- **Release** - how fast the dynamics processor responds to a decrease in input level.
- **Meter** - displays the amount of gain reduction being applied.
- **Make-Up** - controls the output level, post Compression/Limiting or Expansion/Gating.

6.1.4 Transient Phaser

A classic multi-stage allpass based Phaser effect, which can be controlled via LFO or Envelope.

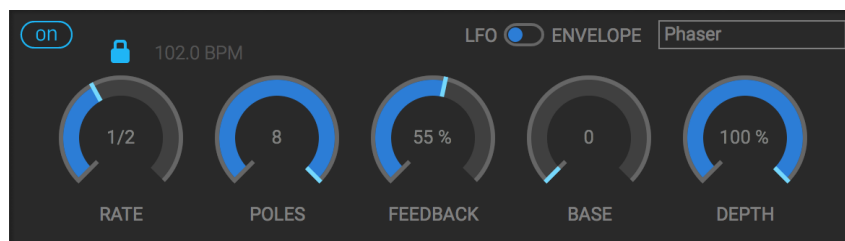

Figure 7: Transient Phaser

Controls:

- **LFO/Envelope Toggle** - controls whether the Phaser is driven by an LFO, or by the envelope of the Transient Effects section input.
- **Tempo Sync Mode** - toggles between session synced (🔒 symbol), manually synced (🔓 symbol), and free-running (🕒 symbol) LFO rate. Only available in LFO mode.
- **Tempo Sync BPM** - sets the BPM when in manually synced Tempo Sync Mode and displays the session BPM in session synced Tempo Sync Mode. Only available in LFO mode.

- **Release** - how quickly the envelope follower decays. Only available in Envelope mode.
- **Rate** - the speed of the LFO. Only available in LFO mode.
- **Poles** - the number of allpass stages in the phaser. A higher number of poles results in a deeper, more intense sound.
- **Feedback** - amount of output from the phaser that is fed back into its input.
- **Base** - the starting point of the phaser, i.e. the point from which the modulation sweeps from. Lower values will allow the phaser to sweep down to lower frequencies.
- **Depth** - how far the modulation can sweep. Higher values will allow the phaser to sweep up to higher frequencies.

6.1.5 Transient Reverb

A room Reverb designed with high echo density, imparting a fast and smooth build-up of reflections. This pairs nicely with transient sounds to create a sense of space without obvious echo slap back.

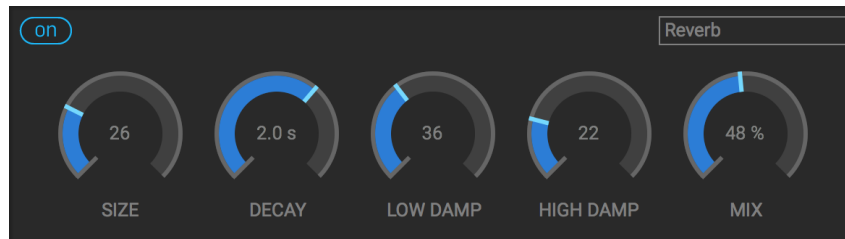

Figure 8: Transient Reverb

Controls:

- **Size** - the perceived "size" of the reverberant space.
- **Decay** - how long it takes the reverberated sound to decay to a level of -60dB (up to 10 secs).
- **Low Damping** - amount of low frequency filtering in the reverberant tail.
- **High Damping** - amount of high frequency filtering in the reverberant tail.
- **Mix** - amount of wet signal to dry signal.

6.1.6 Transient Gate+EQ

A Gate followed by a 3-band overdrive-able EQ.

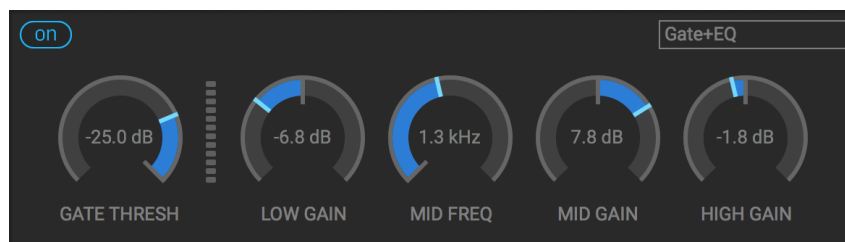

Figure 9: Transient Gate and EQ

Controls:

- **Gate Threshold** - the level at which the Gate opens.
- **Low Gain** - sets the gain for the low-frequency band (200Hz low shelf with Q of 0.5).
- **Mid Frequency** - sets the frequency of the of mid-frequency filter (peak filter with Q of 0.707).
- **Mid Gain** - sets the gain of the mid-frequency filter (peak filter with Q of 0.707).
- **High Gain** - sets the gain of the high-frequency filter (5kHz high shelf with Q of 0.5).

6.2 Transient Effects On/Off

Located in the Effect Block, this button turns the entire Transient Effect Block on or off, regardless of which effect is selected (i.e. if "Off" the Effect Block will remain off even when switching effects).

6.3 Transient Gain

Amount of gain in dB (-96 to +18) applied to the Transient audio post-Effects. This can be used to bring all the Transients up or down. Using this in conjunction with the Tonal Gain alone can lead to dead simple parallel compression effects to easily increase or decrease the "punch" and "body" of percussive audio.

6.4 Transient Solo

Pressing the Transient Solo button will mute the Tonal Channel, effectively the same as turning the Tonal Gain all the way down.

6.5 Transient Output Meter

Displays the output level of the Transient audio stream, post Effect and Gain. Clipping is indicated by the red clip light, which can be cleared by clicking it.

7 Tonal Processing

7.1 Tonal Effects

Post Structural Split, the Tonal signal is independently processed through a selectable Effect Block. The effect is selected with the dropdown menu in the upper right-hand corner of the Effect Block. The Tonal Effect choices are:

7.1.1 Tonal Delay

A standard Delay echo effect with Tempo Sync capability, modulation, and low and high cut filtering.

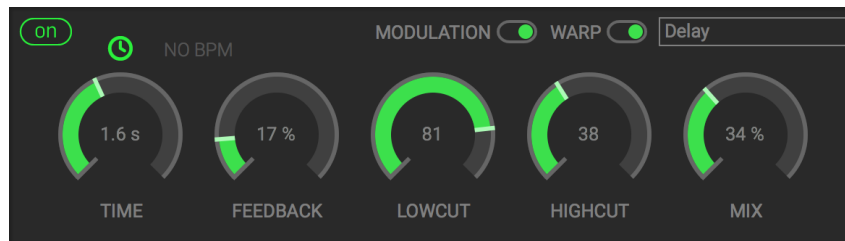

Figure 10: Tonal Delay

Controls:

- **Tempo Sync Mode** - toggles between session synced (🔒 symbol), manually synced (🔓 symbol), and free-running (🕒 symbol) delay time.
- **Tempo Sync BPM** - sets the BPM when in manually synced Tempo Sync Mode, and displays the session BPM when in session synced Tempo Sync Mode.
- **Modulation** - adds random voice chorusing to the delay tap. Warp Off results in crossfading modulation, and Warp On results in regular delay line modulation.
- **Warp** - controls whether changing delay time causes a tape echo type glide (Warp on) or crossfading (Warp off).
- **Time** - amount of delay, up to 4 seconds.
- **Feedback** - amount of delay output that is fed back into delay. Going above 100% allows for self-oscillation.
- **Low Cut** - amount of low-frequency rolloff. Low Cut is in the feedback path.
- **High Cut** - amount of high-frequency rolloff. High Cut is in the feedback path.
- **Mix** - amount of delayed signal to dry signal.

7.1.2 Tonal Compressor

A standard Compressor/Limiter.

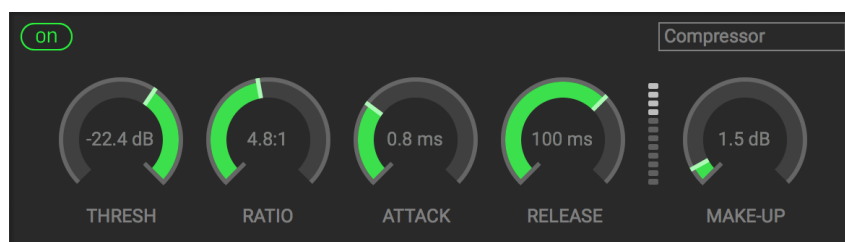

Figure 11: Tonal Compressor

Controls:

- **Threshold** - the level above which gain reduction takes place.
- **Ratio** - how much gain reduction occurs.

- **Attack** - how fast the Compressor/Limiter reacts to change in input level.
- **Release** - how fast the Compressor/Limiter responds to a decrease in input level.
- **Meter** - displays the amount of gain reduction.
- **Make-Up** - controls the effect's output level, post Compression/Limiting.

7.1.3 Tonal Pitch

A 3-voice Pitch Shifter with +/- 1 octave shift per voice and an overall fine tuning control. Useful for retuning drums, creating harmonies, or micropitch chorusing/double-tracking all without transient slap back or smearing (assuming Focus isn't all the way Tonal).



Figure 12: Tonal Pitch

Controls:

- **Interval 1** - the amount of shift for Voice 1 (+/- 1 octave).
- **Pitch Meter** - displays the pitch of the Tonal audio, post Interval 1 and Fine Tune shift amount. This is useful for dialing in the pitch you desire, based on source material.
- **Pitch Meter Toggle** - turns the Pitch meter on/off.
- **Interval 2** - the amount of shift for Voice 2 (+/- 1 octave).
- **Interval 2 Enable** - turns Voice 2 on/off.
- **Interval 3** - the amount of shift for Voice 3 (+/- 1 octave).
- **Interval 3 Enable** - turns Voice 3 on/off.
- **Fine Tune** - overall fine tuning of the whole pitch shifter (applied to all voices).
- **Mix** - amount of processed signal to dry signal.

7.1.4 Tonal Chorus

A deep multi-voiced Chorus with randomized modulation. Structural Split separation of Transients allows this chorus to go deep and wide on Tonal audio without transient slap or smearing.

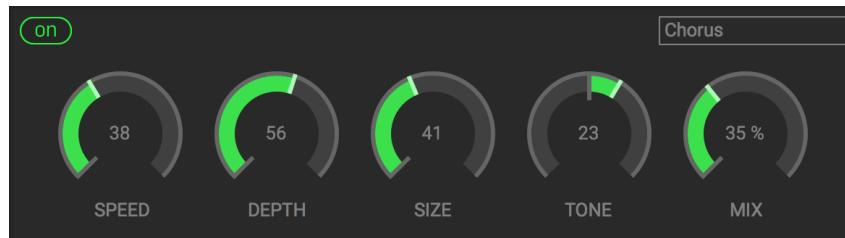

Figure 13: Tonal Chorus

Controls:

- **Speed** - adjust the modulation speed of the chorused voices.
- **Depth** - how deep the chorus sounds. Larger values will result in a broader, more sweeping sound.
- **Size** - the spread of the chorused voices.

- **Tone** - filtering of the chorused signal. Turning clockwise increases high-shelf filtering, while turning counter-clockwise increases low-shelf filtering.
- **Mix** - amount of processed signal to dry signal.

7.1.5 Tonal Reverb

A large space Reverb designed with lower echo density (compared to Transient Reverb) and targeted high modal density with little to no modulation to avoid a chorusing sound on the tails. The allows the tonal audio to breath in the space, yet evolve into dense pad-like reverberant tails.

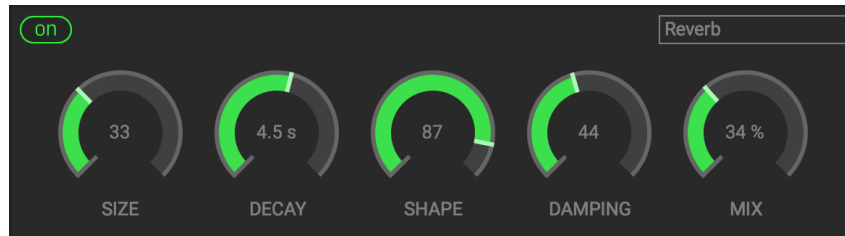

Figure 14: Tonal Reverb

Controls:

- **Size** - the perceived "size" of the reverberant space.
- **Decay** - how long it takes the reverberated sound to decay to a level of -60dB (up to 100 secs).
- **Shape** - the perceived "shape" of the reverberant space.
- **Damping** - amount of high frequency filtering.
- **Mix** - amount of wet signal to dry signal.

7.1.6 Tonal Tremelo

A standard Tremolo Effect which is driven by an LFO in (optional) combination with the Envelope of the plug-in's input.

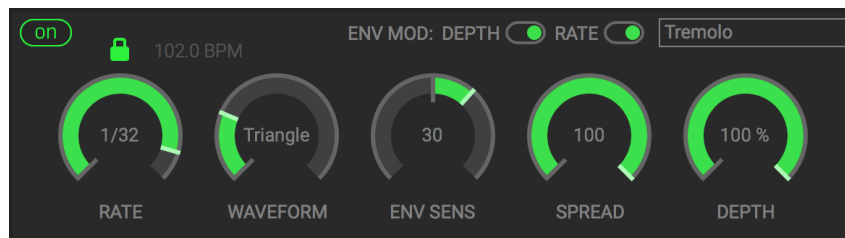

Figure 15: Tonal Tremolo

Controls:

- **Tempo Sync Mode** - toggles between session synced (🔒 symbol), manually synced (🔓 symbol), and free-running (🕒 symbol) LFO rate.
- **Tempo Sync BPM** - sets the BPM when in manually synced Tempo Sync Mode, and displays the session BPM when in session synced Tempo Sync Mode.
- **Envelope Modulation Destination** - these two toggle switches select what parameters the plug-in input should modulate.
- **Rate** - the speed of the LFO.
- **Waveform** - selects the waveform type for the LFO.
- **Envelope Sensitivity** - controls how much the Envelope of the plug-in's input will modulate Rate and/or Depth (depending on what is selected in Envelope Modulation Destination). This is in addition to the already set Rate and/or Depth values. Positive Sensitivity values will modulate Depth and/or Rate up from their current values, while negative Sensitivity values perform an Inverse

Envelope effect, where Depth and/or Rate will be modulated down from their current values. Note that you might need to set Depth and Rate appropriately to hear this effect, as these controls are still bounded by their minimum and maximum.

- **Spread** - controls the stereo spread of the Tremolo. This effectively pushes the LFO of the right channel out of phase with the left channel LFO, until they are fully out of phase (180 degrees). At maximum, the Tremolo becomes an Auto-Panner. Note that this control is not available in mono instances of Physion.
- **Depth** - the amount of Tremolo effect applied to the signal.

7.1.7 Tonal EQ

A 3-band overdrive-able EQ.



Figure 16: Tonal EQ

Controls:

- **Low Gain** - sets the gain for the low-frequency band (200Hz low shelf with Q of 0.5).
- **Mid Frequency** - sets the frequency of the of mid-frequency filter (peak filter).
- **Mid Frequency** - sets the Q of the of mid-frequency filter (peak filter).
- **Mid Gain** - sets the gain of the mid-frequency filter (peak filter).
- **High Gain** - sets the gain of the high-frequency filter (5kHz high shelf with Q of 0.5).

7.2 Tonal Effects On/Off

Located in the Effect Block, this button turns the entire Tonal Effect Block on or off, regardless of which effect is selected (i.e. if "Off" the Effect Block will remain off even when switching effects).

7.3 Tonal Gain

Amount of Gain in dB (-96 to +18) we apply to the Tonal audio post Effects. Using this in conjunction with the Transient Gain alone can lead to dead simple parallel compression effects to easily increase or decrease the "punch" and "body" of percussive audio.

7.4 Tonal Solo

Pressing the Tonal Solo button will mute the Transient Channel, effectively the same as turning the Transient Gain all the way down.

7.5 Tonal Output Meter

Displays the output level of the Tonal audio stream, post Effect and Gain. Clipping is indicated by the red clip light, which can be cleared by clicking it.

8 Preset Bar

The Preset Bar is used for loading and saving Physion Presets, as well as controlling the Global Mix and Gain of Physion.

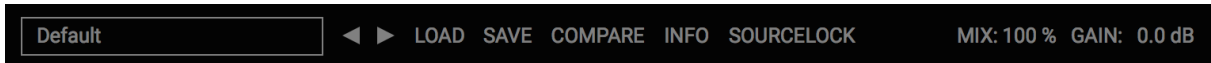

Figure 17: Preset Bar

8.1 Global Mix

Controls the Global Wet/Dry mix of the entire plug-in.

8.2 Global Gain

Controls the overall Gain (-24 dB to +18 dB) of the entire plugin-in.

8.3 Saving and Recalling Plug-In Settings

When Physion is installed, a library of settings is placed into the `<user>/Music/Eventide/Physion/Presets` folder (Mac) or `<user>/Documents/Eventide/Physion/Presets` folder (Windows). These presets have a `.tide` extension and can be saved or loaded from the Physion preset bar in any supported DAW.

In many DAWs there is an additional generic preset bar that saves DAW-specific presets to a separate location. We recommend saving your presets using the Eventide preset bar to ensure that your presets will be accessible from any DAW. You can also create sub-folders inside the Physion Preset Folders, if you wish

8.4 Compare

Compare becomes illuminated when a preset has changed. Clicking Compare toggles between the unaltered preset and the adjusted state of the preset.

8.5 Info

The INFO button enables easy access to documentation from the preset bar. Clicking on it opens this user guide in your default PDF viewer. This user guide is located along with your presets in your `<user>/Music/Eventide/Physion` folder (Mac) or `<user>/Documents/Eventide/Physion` folder (Windows).

8.6 Source Lock

This locks the Structural Split Source Type (see Structural Split Processing section for more detail) during Preset loading. Locking the Source Type ensures that the splitting algorithm stays optimized as you try different Presets on the same source material.

9 Conclusion

We hope you enjoy the Eventide Physision plug-in and put it to good use in all of your mixes and sound design projects. Please be sure to check over Eventide's other Native Plug-In offerings for more unique and interesting effects.